

Cineroid

Cinema & Broadcasting Equipment

LM200

ON CAMERA LED LIGHT

English

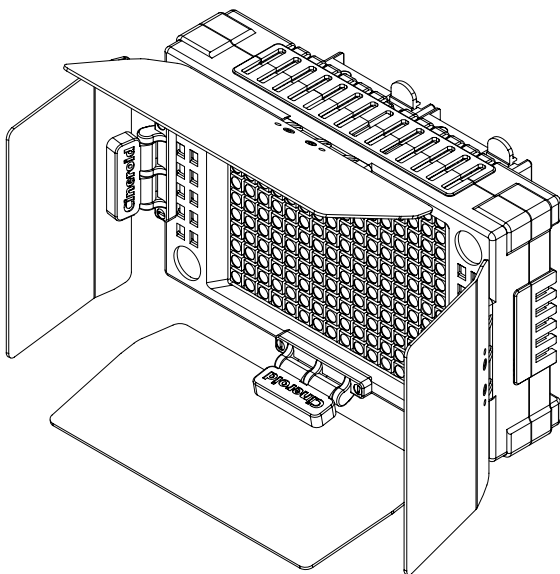

Variable Color Temperature
High Power LED Light Source
Dimming Brightness 30 steps
Attachable Battery
Connecting External Power
Support for variety Accessories

User's Manual

Thank you for purchasing the Cineroid LED light.

The Cineroid LED employs a very high color rendering index (CRI).

It displays a very stable color temperature and brightness so that both motion pictures and still images can be taken in their most natural color tones.

Please read this user manual thoroughly before using the Cineroid LED.

| Test Before Operating

It is recommended to test the Cineroid LED before use. Make sure the light comes on when powered and that the brightness control works properly.

| Copyrights and Prohibitions

The use of images of people, property, and places can without permission can be prohibited by law. Please refer to your region's laws regarding copyrights.

-
- Canon and EOS are registered trademarks of Canon.
 - Nikon is a registered trademark of Nikon.
 - Sony is a registered trademark of Sony.
 - Panasonic is a registered trademark of Panasonic.
-

Safety Precautions

Please observe the following safety precautions as they are meant for the safe and proper use of the product to reduce the risk of accidents. Upon reading the user manual, keep it in a safe and available place.

- ⦿ Do not use any batteries, power cord, or accessories that are not specified in this document.
- ⦿ When using a power cord, be sure to plug it in completely. Do not handle power plugs when your hands are wet. When unplugging the power cord, grasp the plug body or adapter instead of the cord.
- ⦿ Power cords that are scratched, heavily bent or twisted can potentially be hazardous and a source of electric shock and/or fire.
- ⦿ Do not insert foreign objects into the product's electric or cable components.
- ⦿ Do not place the power cord near sources of heat as this may melt or cause damage to the cord potentially causing fire or electric shock.
- ⦿ Do not disassemble or modify the product. This may damage the product and cause danger due to a malfunction.
- ⦿ Please keep the product out of reach of young children. Injuries may occur due to damage to the product.
- ⦿ When using the product in an airplane or hospital setting, it is recommended to acquire authorization first as signals or electro-magnetic waves from the product may cause other equipment to malfunction.
- ⦿ Do not store the product in a dusty or humid environment as damage may occur.
- ⦿ When the product is mounted on a camera, do not lift or move the camera by grabbing the product. This may cause damage to the product or the camera mount.
- ⦿ Do not clean the product with paint thinner, benzene, or other volatile solvents. It may cause damage to the product and become a fire hazard.
- ⦿ This product is not waterproof. If the product is dropped in water, contact the service center immediately.

Table of Contents

Safety Precautions	03
Table of Contents	04
Components	05
Names of Parts	06
Installing the Battery	07
Powering On/Off	07
Adjusting Brightness / Color temperature	08
Mounting Diffuser Pannel	09
Connecting External Power	09
Product Specification	10
Optional Products	10

Components

Please ensure all parts are present after opening the box.

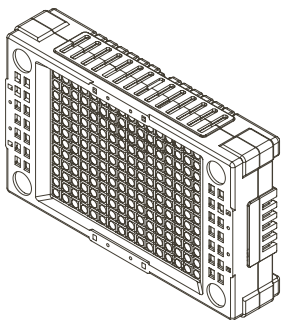

A. LM200 Body

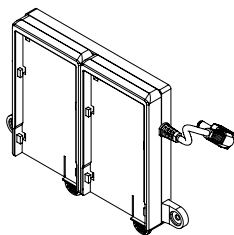

C. Battery Mount



C. Mini Ball Head

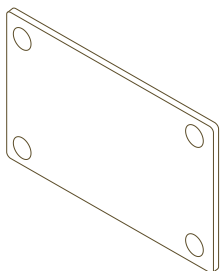

D. Diffuser panel



E. User's Manual



F. Bag

Parts

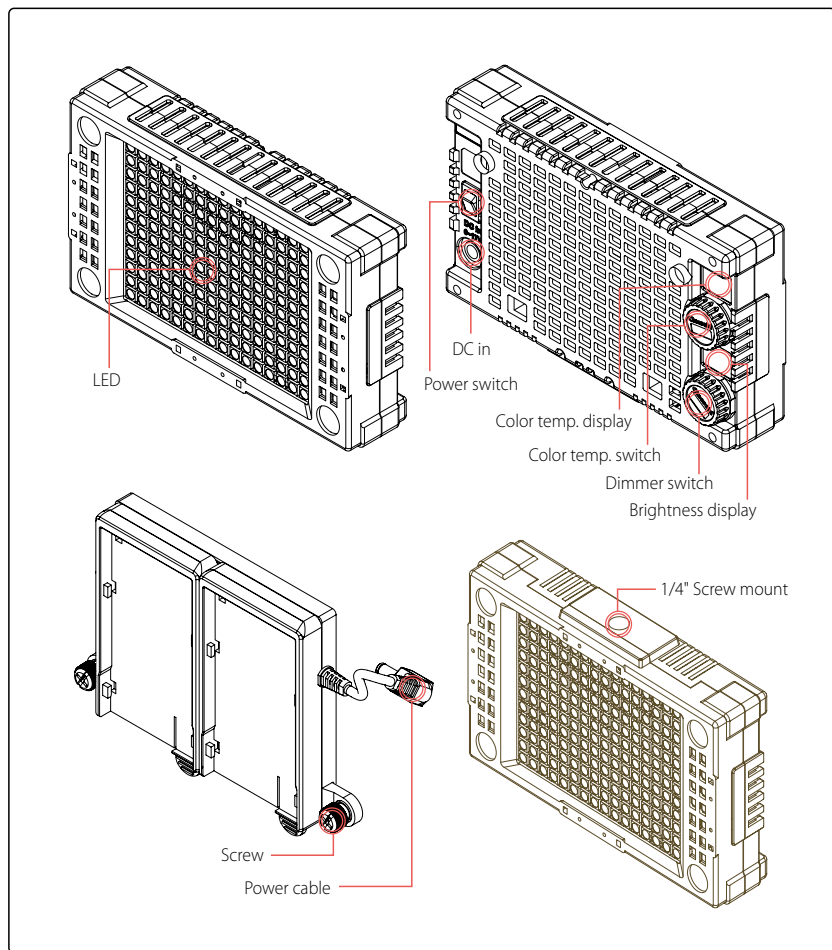

Installing the Battery

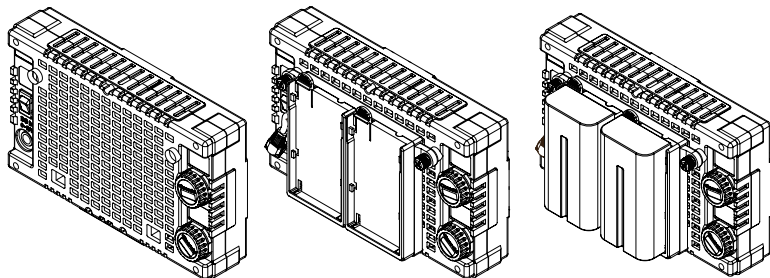

1. Attach the battery mount to the back of the body with the use of the two screws on the mount.
2. Connect the cable on the battery mount to the body.
3. Attach the battery to the battery mount.
4. Be sure to charge fully the battery before installing.
5. Sony NPF Type battery is compatible.

Powering On/Off

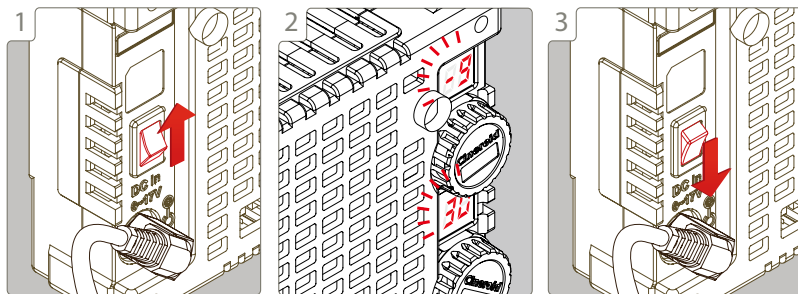

1. Push the power switch "ON" to turn on the LED light.
2. Check if the information is displayed properly.
3. Push the power switch "OFF" to turn off the LED light.

Adjusting Brightness / color temperature value

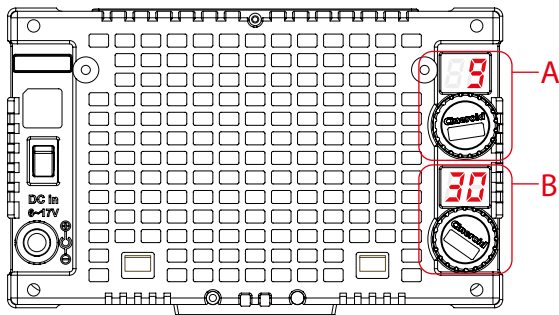

A. Adjusting color temperature

1. The LM200 can be changed color temperature by color temperature switch.
2. LCD displays color temperature value from 9 to -9.
3. The highest value on the LCD is 9 that represents daylight and -9 is tungsten.

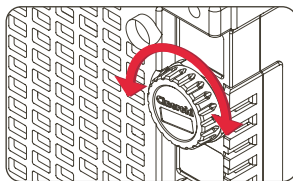
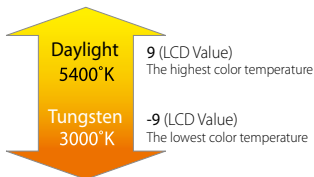

B. Adjusting Brightness

1. Turn the dimmer switch side to side to adjust the brightness.
2. The brightness range is from 0~30 and the current level is displayed on LCD.
3. Turning the dial to the right increases brightness.
4. Turning the dial to the left decreases brightness.
5. When brightness value is zero, LED lights become off.

Mounting the diffuser panel

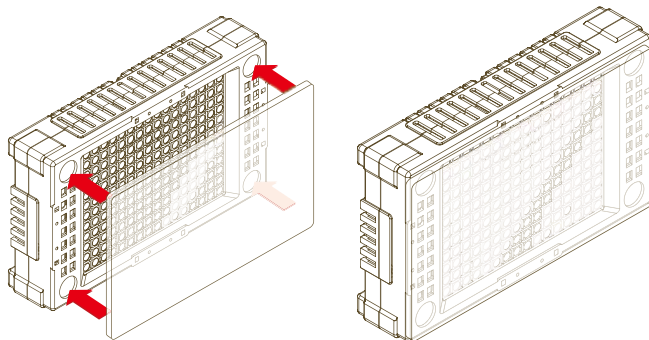

1. Mounting the diffuser panel will prevent the light from spreading to the sides.

Connecting External Power

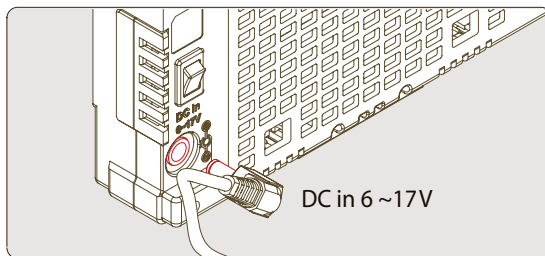

1. In addition to the rechargeable battery, external power sources can also be used to power the light.
2. 12V, 3A power is recommended for external power.
3. Remove the battery mount plug from the body.
4. Insert the power plug from the external power source.

LM200 Specification

Size	152 x 94 x 35 mm
Power input	6 ~17 V
Light angle	120 degree
Brightness step	30 steps
Mount	1/4" Screw mount
External power	D-tap cable(optional)
Weight	281 g (without Battery)
Display info.	Brightness, Channel, Color Temp., Error warning
Photometric	720 Lux / 1m
Color Temp.	3000°K~5400°K ±200°K
Power drain	30 W

Optional Accessoires

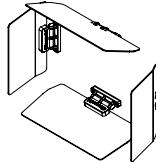
Model	Form	Remarks
PA05		DC plug with D-tap
BD02		Barn door

Memo

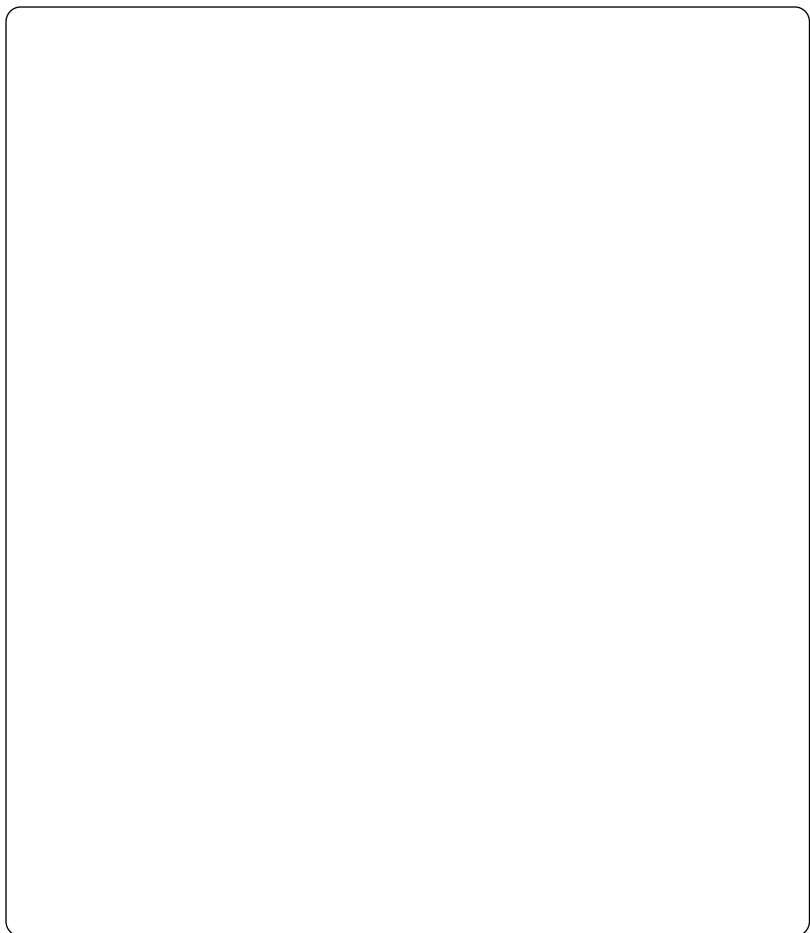

Cineroid

Cinema & Broadcasting Equipment

LM200

ON CAMERA LED LIGHT

Customer Support Center

Seculine Co., LTD.

Tel +82.70.4347.4901 / **Fax** +82.2.850.3027

SECULINE CO., Ltd. Room.510, 55 (Kolon Science Vally #2), Digital-ro 34-gil, Guro-gu, Seoul, KOREA 152-728

Homepage www.cineroid.com

E-mail support@secu-line.com

LM200-1.0V Printed in Korea